



Bearing Model ST211-1-3/4

Overall dimension (mm)

d 44.45

D 139.7

B 55.5

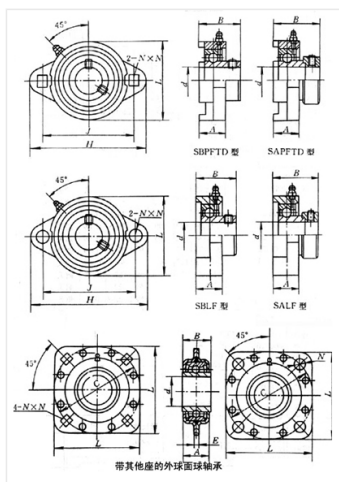

Limit speed (RPM)

Grease -

Oil lubrication -

Rated load

Cr(N) -

Cr(N) -

Weight(kg) 0