



Bearing Model BK0609

Overall dimension (mm)

d 6

D 10

B 9

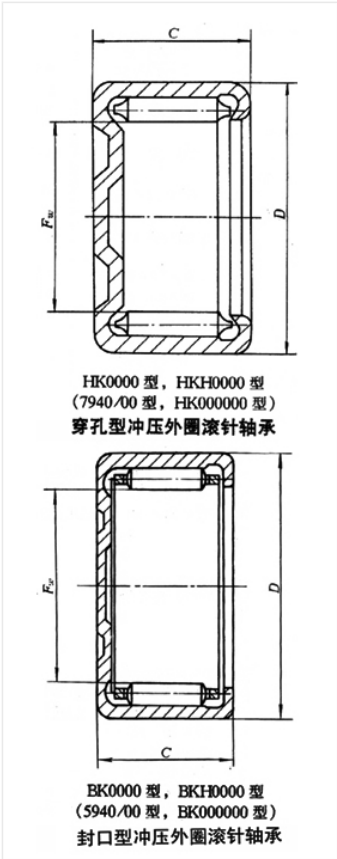

Limit speed (RPM)

Grease -

Oil lubrication -

Rated load

Cr(N) -

Cr(N) -

Weight(kg) -