



Bearing Model HK0910

Overall dimension (mm)

d 9

D 13

B 10

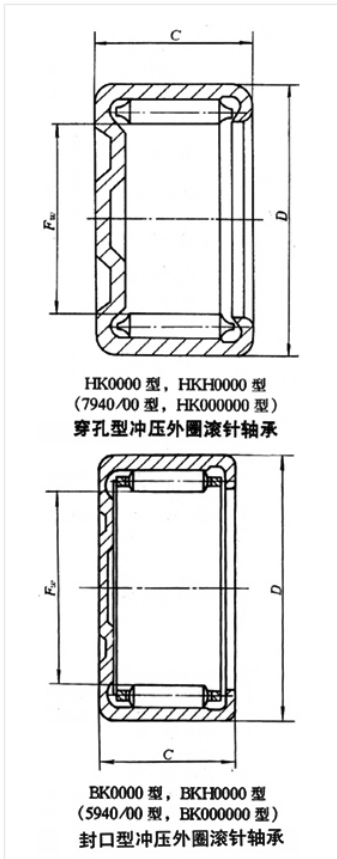

Limit speed (RPM)

Grease -

Oil lubrication -

Rated load

Cr(N) -

Cr(N) -

Weight(kg) -