



Bearing Model HK0912

Overall dimension (mm)

d 9

D 13

B 12

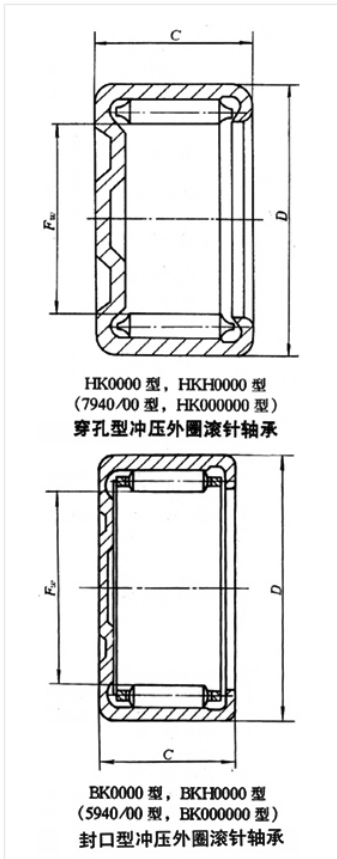

Limit speed (RPM)

Grease -

Oil lubrication -

Rated load

Cr(N) -

Cr(N) -

Weight(kg) -