



Bearing Model K18X24X17

Overall dimension (mm)

d 18

D 24

B 17

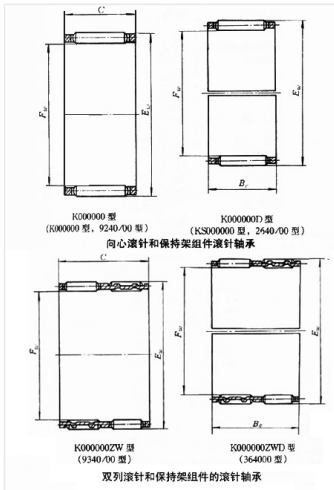

Limit speed (RPM)

Grease -

Oil lubrication -

Rated load

Cr(N) -

Cr(N) -

Weight(kg) -