



Bearing Model K22X26X17

Overall dimension (mm)

d 22

D 26

B 17

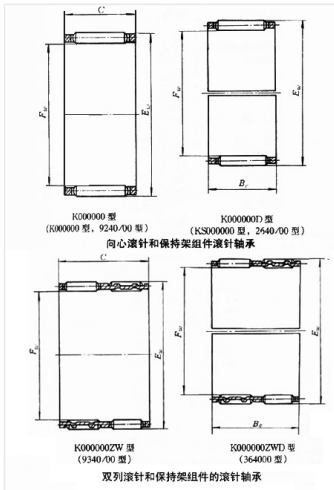

Limit speed (RPM)

Grease -

Oil lubrication -

Rated load

Cr(N) -

Cr(N) -

Weight(kg) -