



Bearing Model K40X45X27

Overall dimension (mm)

d 40

D 45

B 27

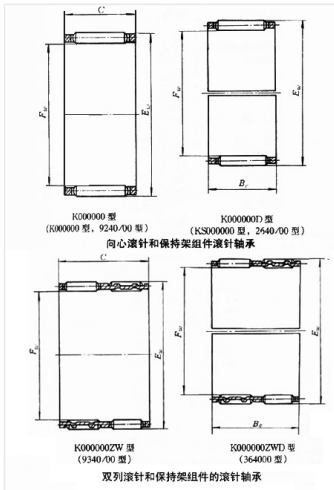

Limit speed (RPM)

Grease -

Oil lubrication -

Rated load

Cr(N) -

Cr(N) -

Weight(kg) -