



Bearing Model K40X47X20

Overall dimension (mm)

d 40

D 47

B 20

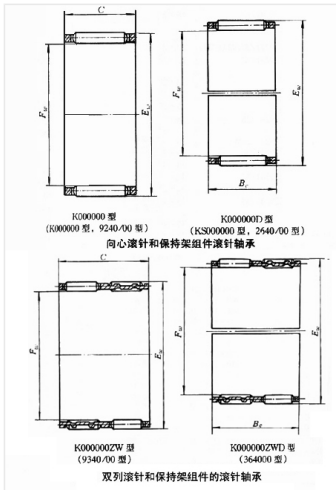

Limit speed (RPM)

Grease -

Oil lubrication -

Rated load

Cr(N) -

Cr(N) -

Weight(kg) -