



Bearing Model K50X55X20

Overall dimension (mm)

d 50

D 55

B 20

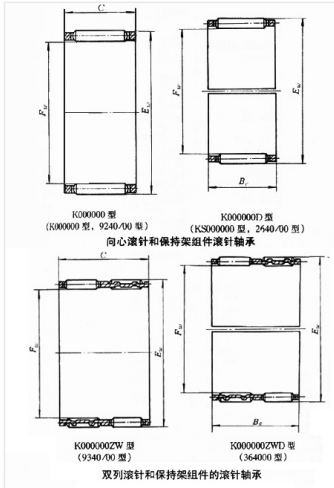

Limit speed (RPM)

Grease -

Oil lubrication -

Rated load

Cr(N) -

Cr(N) -

Weight(kg) -