



Bearing Model K42X47X27

Overall dimension (mm)

d 42

D 47

B 27

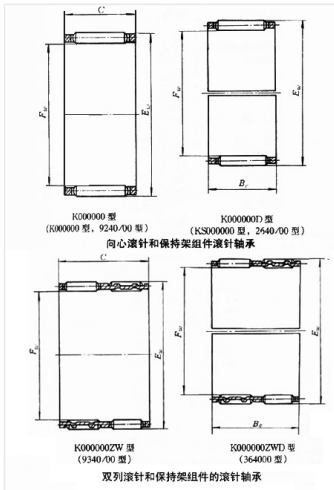

Limit speed (RPM)

Grease -

Oil lubrication -

Rated load

Cr(N) -

Cr(N) -

Weight(kg) -