



Bearing Model K80X88X25

Overall dimension (mm)

d 80

D 88

B 25

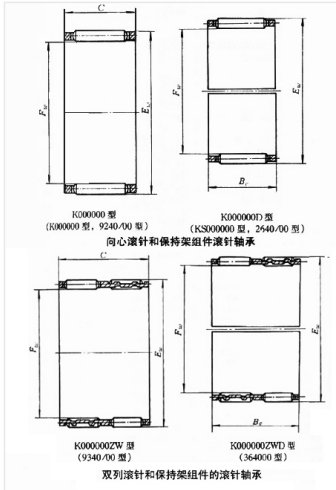

Limit speed (RPM)

Grease -

Oil lubrication -

Rated load

Cr(N) -

Cr(N) -

Weight(kg) -