



Bearing Model HKH0812

Overall dimension (mm)

d 8

D 14

B 12

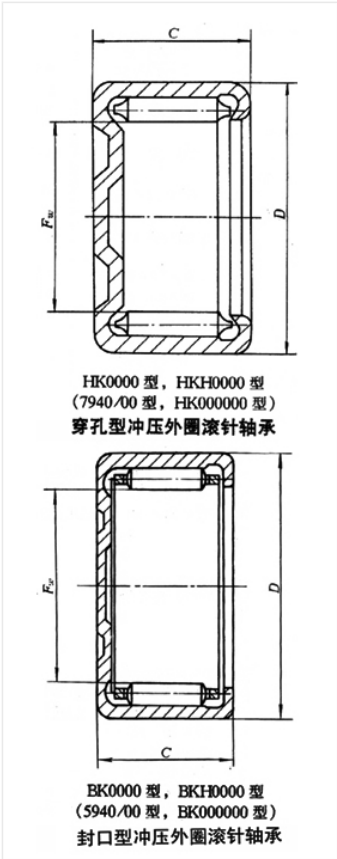

Limit speed (RPM)

Grease -

Oil lubrication -

Rated load

Cr(N) -

Cr(N) -

Weight(kg) 0