



Bearing Model HK4520B

Overall dimension (mm)

d 45

D 52

B 20

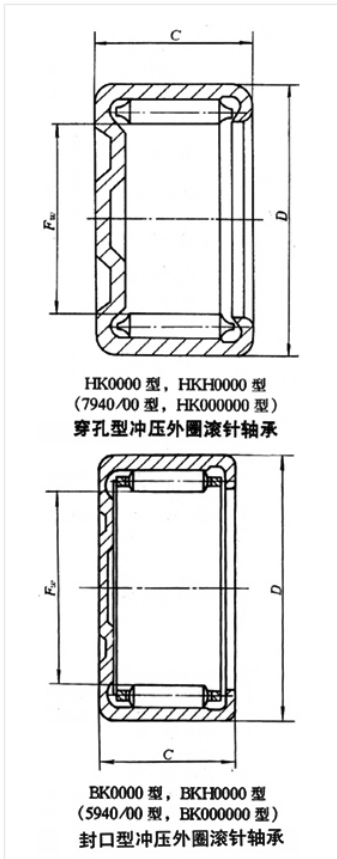

Limit speed (RPM)

Grease -

Oil lubrication -

Rated load

Cr(N) -

Cr(N) -

Weight(kg) 0.067