



Bearing Model HK3516B

Overall dimension (mm)

d 35

D 42

B 16

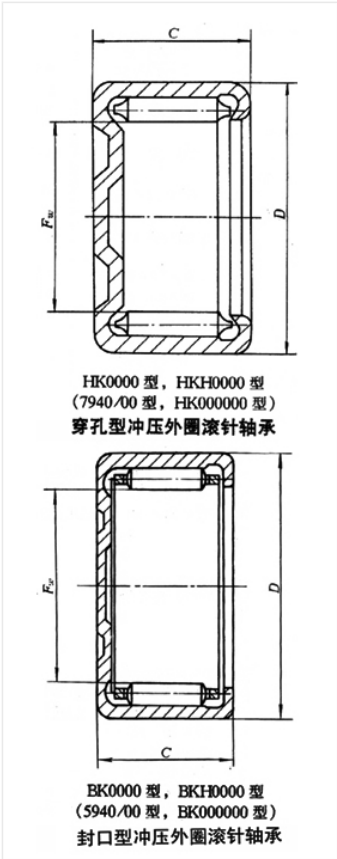

Limit speed (RPM)

Grease -

Oil lubrication -

Rated load

Cr(N) -

Cr(N) -

Weight(kg) 0.046