



Bearing Model HK1412B

Overall dimension (mm)

d 14

D 20

B 12

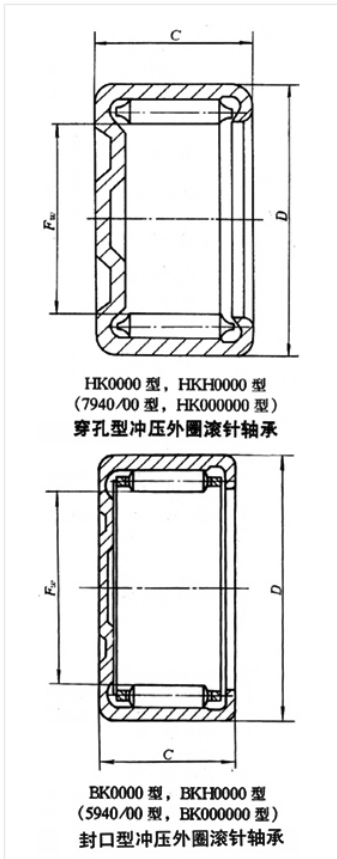

Limit speed (RPM)

Grease -

Oil lubrication -

Rated load

Cr(N) -

Cr(N) -

Weight(kg) 0.011